



Landscape Products
and Special Bricks



Landscape
Products

YORK
Handmade

Landscape Products

Brick Paver

Traditional hand-moulded clay pavers.

215 x 102.5 x 65 65mm - S121

215 x 102.5 x 50 50mm - S120



Square Landscape Paver

These pavers are ideal for a user who requires a square rather than a rectangular format.

200 x 200 x 50 S255



Cobbles

Due to the convenient size of the cobbles the designer can easily use this product for circles or serpentine style bends in paths or patios.

100 x 100 x 65



Bullseye

The bullseye kit is already cut out to suit a circular feature and allows the user to provide a focal point for their garden.

YHMB13



Stepping Stones

A novel feature of aesthetic appeal which will also avoid those unsightly tread marks on your favourite lawn. Can be used as a feature in your garden landscape.

YHMB14



Manufactured by hand
from clay found in
North Yorkshire



A photograph of a stone-paved path leading towards a gazebo in a garden. The path is made of large, rectangular, reddish-brown stone pavers. To the left of the path is a rough, stone-lined area. In the background, there are lush green trees and a gazebo with arched windows. The overall scene is bright and sunny.

Patterned Pavers

YORK
Handmade

A logo graphic consisting of three stylized, overlapping chevron shapes pointing to the right, located below the text 'YORK Handmade'.

Patterned Pavers

Oakleaf Paver

215 x 102 x 65 YHMB1



Diamond Paver

215 x 110 x 65 YHMB2



Rose Brick

215 x 110 x 65 YHMB3



Rose Square

150 x 150 x 65 YHMB5



Diamond Cobble

102 x 102 x 65 YHMB6



Rose Cobble

102 x 102 x 65 YHMB7



Inspired by old Italian designs these garden edging bricks and feature pieces are ideally used to finish off paved areas whether they be in clay or other landscape materials.





Garden Edgings

YORK
Handmade



Garden Edgings



Upright Garden Edging

250 x 100 x 50 YHMB4

Fenestre Garden Edging

275 x 280 x 30 YHMB9



Cloister Garden Edging

250 x 260 x 20 YHMB10

Floral Garden Edging

300 x 280 x 30 YHMB11



Rope Garden Edging

260 x 150 x 30 YHMB12

Garden edgings are the ideal complement to handmade pavers or can be used with other landscape materials.



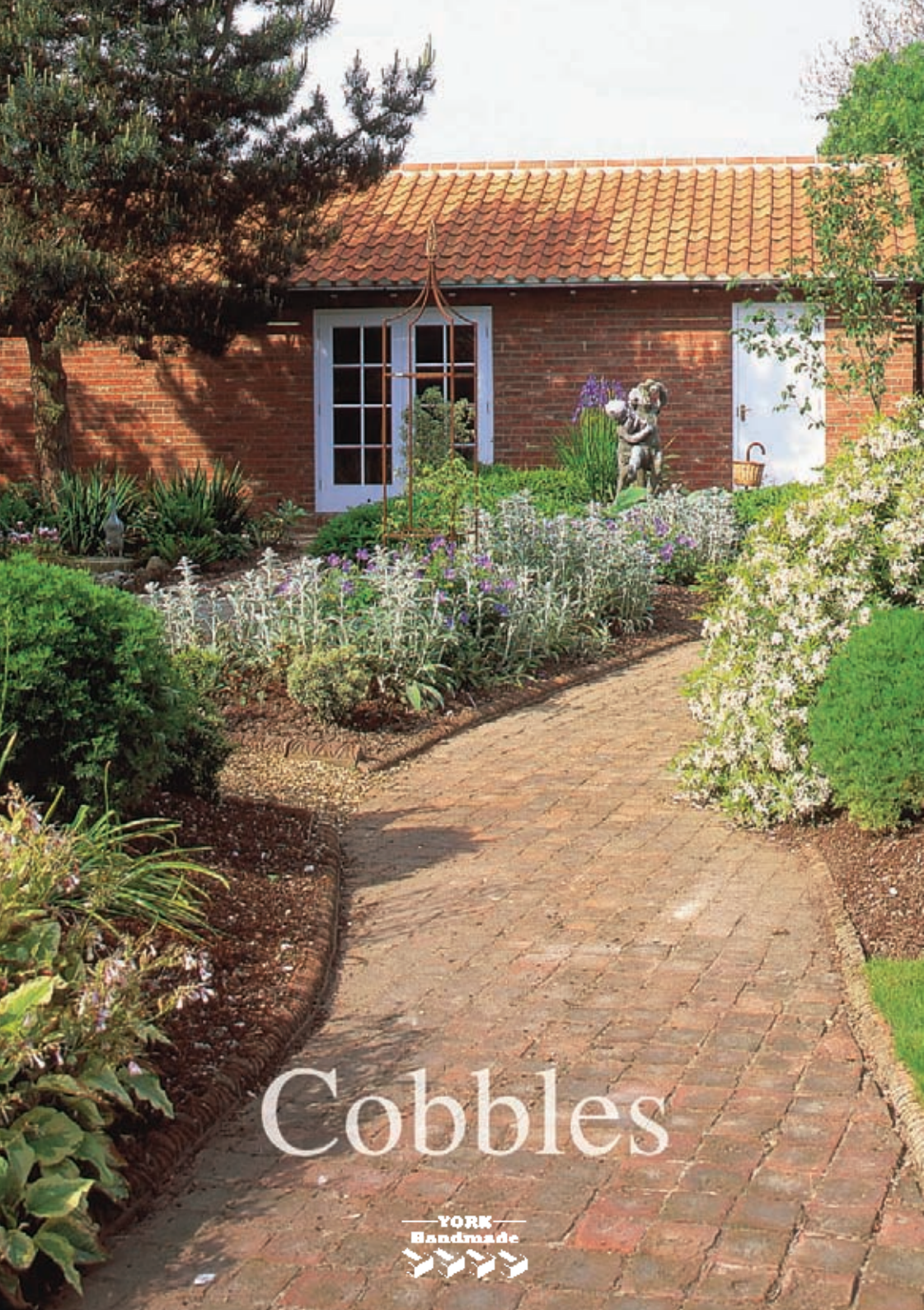

Cobbles

Cobbles

These products are rough looking but rugged in performance to offer the landscaper an alternative clay product to aid his design. Its small scale makes it ideal for patterns or curves. Like all our products it weathers fast and looks old from the moment it is laid.

The picture also shows the upright garden edgings which are an ideal feature with which to border the area on which the cobbles are used be it a path, a patio or just a feature in your garden.

Size: 100 x 100 x 65mm.



Garden edgings are the ideal complement to handmade pavers or can be used with other landscape materials.



Brick Pavers

The walled garden at Scampston Hall in North Yorkshire has been completely restored from an original Capability Brown project which had become derelict over many years. This has now been completely restored using a modern design by Piet Oudolf. The paths and details form a contrast to the soft landscape in this 4½ acre garden. The pavers were chosen for their rugged, weathered look in competition with many other products.



Garden edgings are the ideal complement to handmade pavers or can be used with other landscape materials.



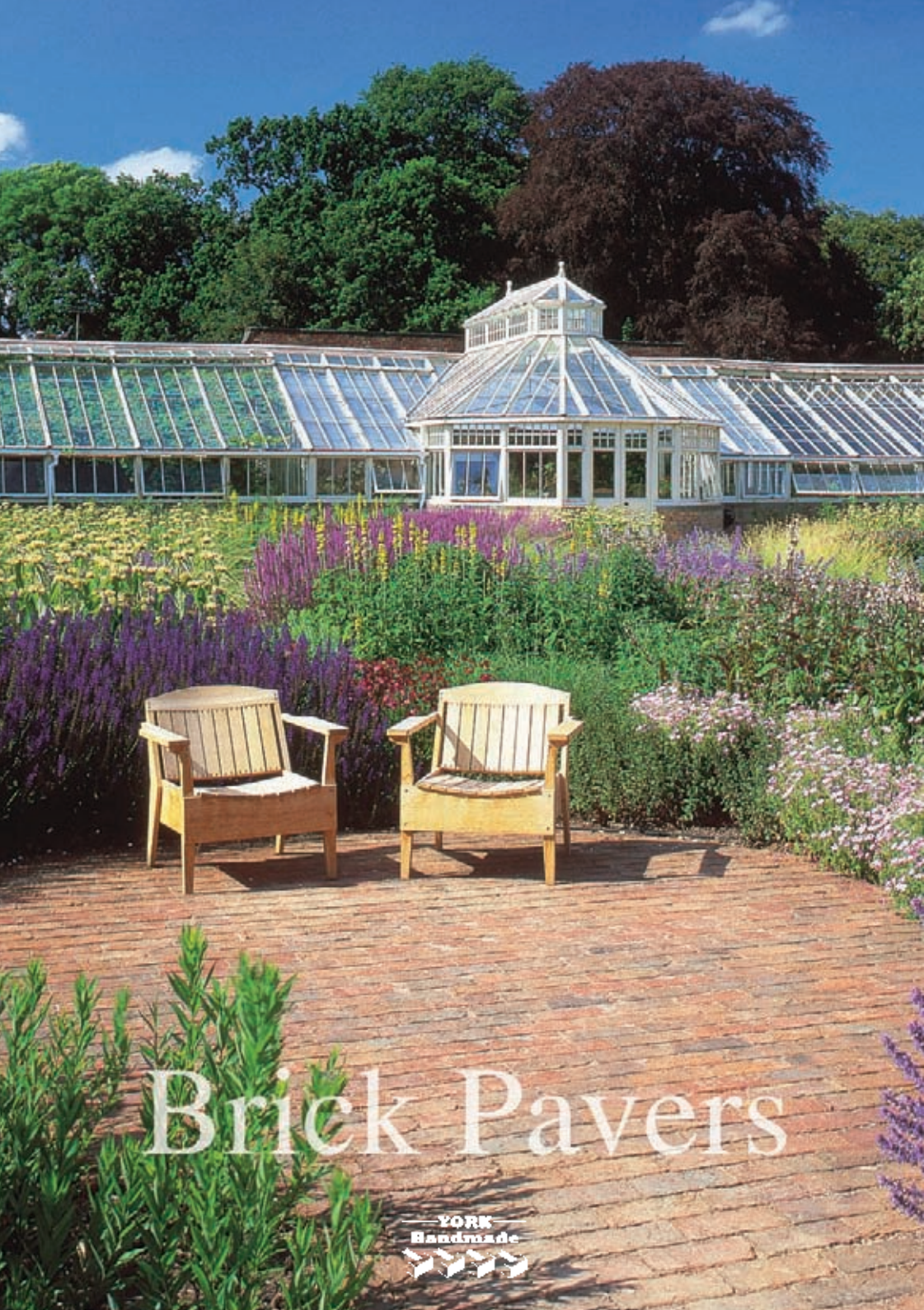

Brick Pavers

YORK
Handmade



Brick Pavers and Cobbles

Left: Brick Pavers in use at the walled garden at Scampston Hall in North Yorkshire.

The photograph below shows Rose Cobbles (YHMB7) and Upright Garden Edgings (YHMB4) which are an ideal feature with which to border an area of cobbles or other landscape products.



Garden edgings are the ideal complement to handmade pavers or can be used with other landscape materials.



A photograph of a brick paver path in a garden. The path is made of reddish-brown bricks and leads through a lush garden with various plants, including purple flowers and green foliage. In the background, there are large trees and a blue sky with white clouds.

Brick Pavers

YORK
Handmade

The logo for York Handmade, featuring a stylized graphic of three interlocking shapes below the text.



Isle of Wight

This landscape was installed during the restoration of a kitchen garden part of a period country house in the Isle of Wight. It was designed by Philippa Lambert who has blended the hard and soft landscape perfectly in this picture.



*York Handmade pavers
complement a beautiful array of
flora and fauna to make a
perfect combination.*





YORK
Handmade

Brick in the Garden

This picture is included in our brochure to illustrate how well genuine handmade bricks enhance an English country garden. On the right hand side of the picture in the forefront you can see a pergola built out of cant bricks, just another example of versatility and imaginative design. Brick in the garden complements the soft landscape like no other and immediately looks comfortable in its setting.



The flowerpot in the foreground is also made from the Lacustrine clay from which all York Handmade products are manufactured.



YORK
Handmade



Garden Walls

The walled garden at Scampston Hall, near Scarborough, Yorkshire is featured on another page. We are using the same scheme to illustrate how well the bricks are detailed and laid by good craftsmen to make the ideal backcloth for any garden or hard landscape.

Featured in this picture are 50mm (2") and we would draw attention of the reader to the excellent pointing and detailing in the wall.

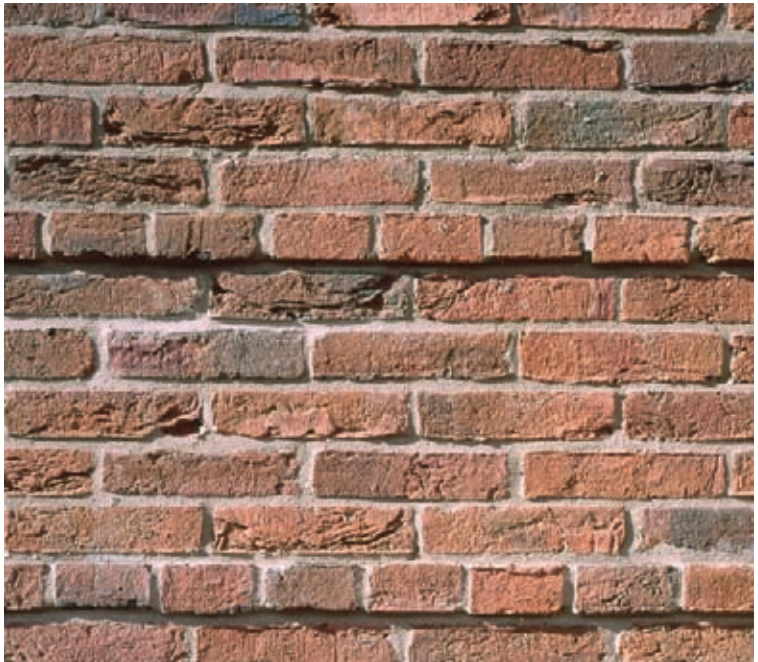

Always remember that the choice of joint and mortar colour is a critical part of any successful brickwork scheme.





YORK
Handmade

Chelsea 2007

These bricks were supplied to one of the gold award winning projects at the 2007 Show. The scheme designed by Adam Frost was entitled "Realistic Retreat" and was designed for an urban landscape where space was limited. The idea is to give the urban dweller a sense of tranquillity.



Bricks and other landscape products can be used equally well in an urban garden as in a country situation.





Specials

Specials

Squint

AN1

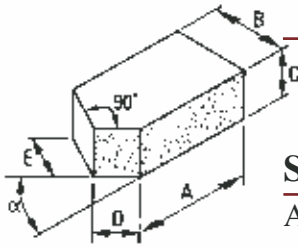

LH shown

Single Cant

AN5

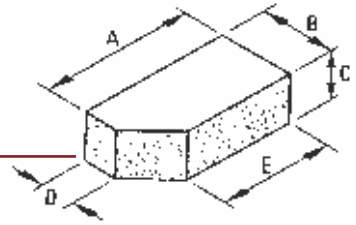

LH shown

External & Internal Dogleg

AN2 & 3

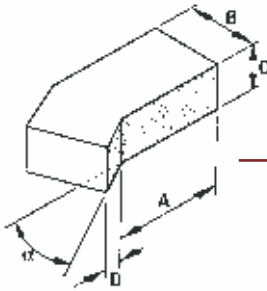

LH shown

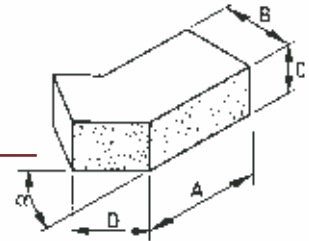

LH shown

Single Cant Ext Return

AN7

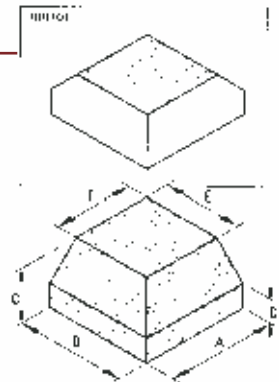
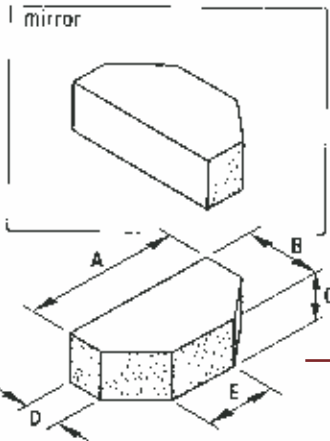

Double Cant

AN6

The vast range of specials manufactured by York Handmade can be used to good advantage in any landscape situation especially where you wish to change levels or alter the profile of your design.



Specials (Cont.)

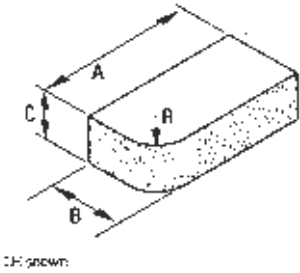

Single Bullnose

BN1.2

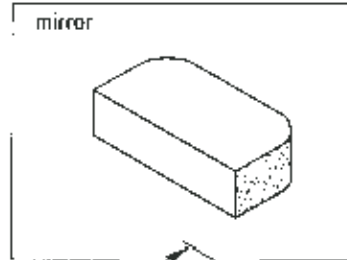

Double Bullnose

BN2.2

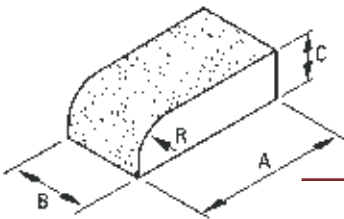
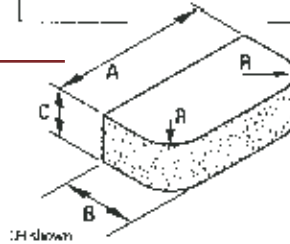

Single Bull Header on Flat

BN5.2

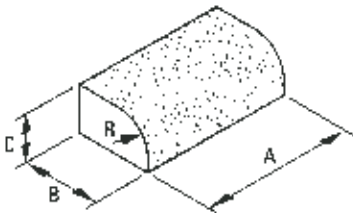

Single Bull Stretcher on Flat

BN6.2

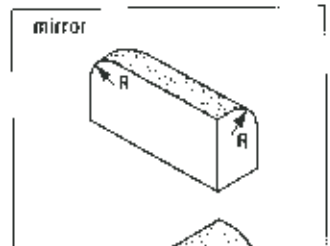

Bull Ext RT on Edge

BN10

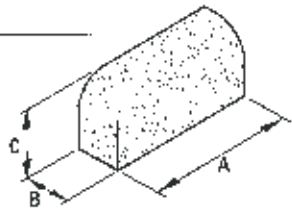

:H shown

Specials (Cont.)

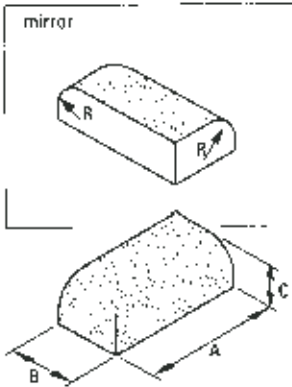

Bull Ext RT on Flat

BN11

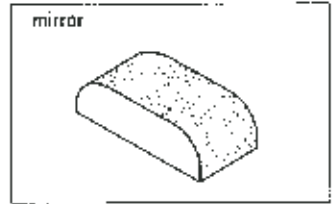

Bullnose DB Header on Flat

BN13

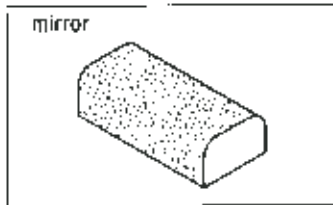
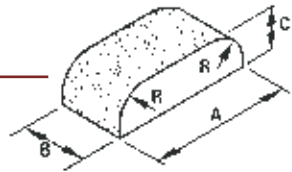

Bullnose DB Stretcher on Flat

BN14

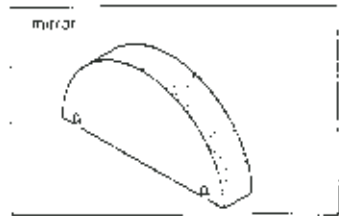
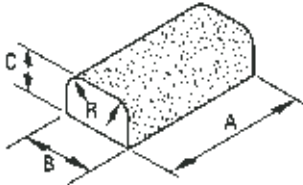

Half Round Coping

CP1.1

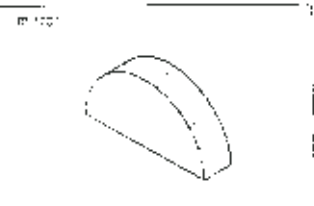
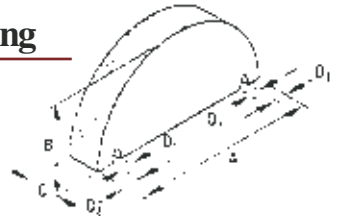

Half Round Capping

CP1.2

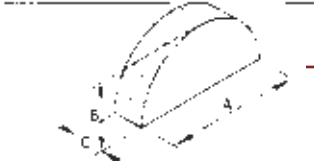

Specials (Cont.)

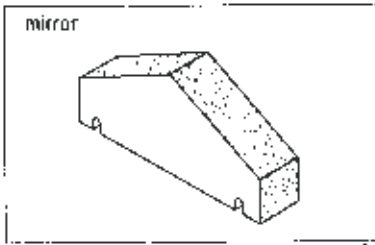

Saddleback Coping

CP2.1

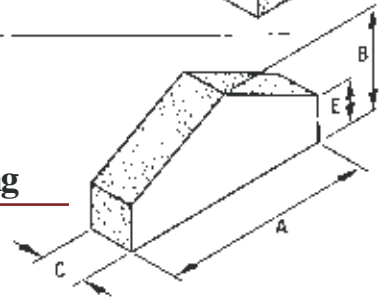
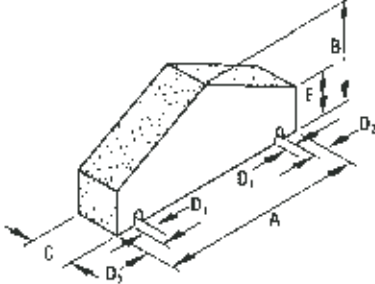
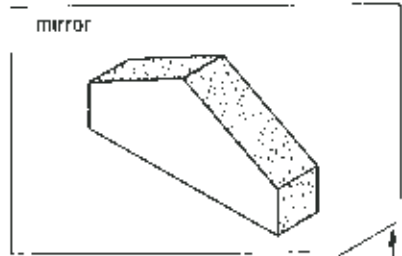

Saddleback Coping

CP2.2

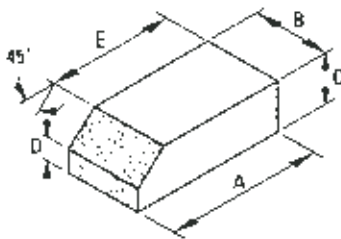

Plinth Header

PL2

Plinth Stretcher

PL3

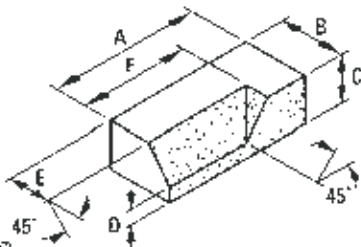
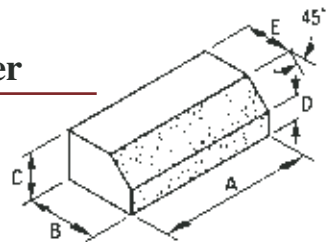

Plinth Internal Return Long

PL4

Specials (Cont.)

Plinth External Return Left or Right Hand

PL7

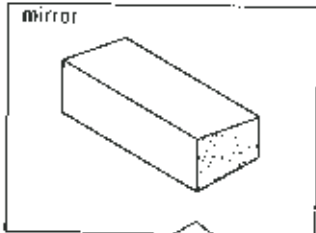
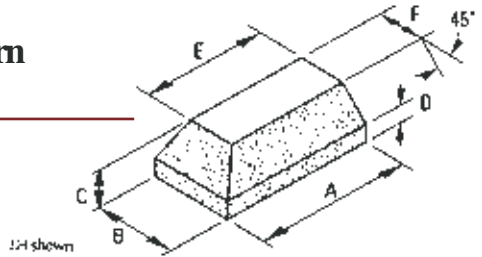

Tapered Header

AR1

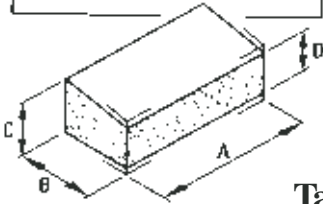

Tapered Stretcher

AR2

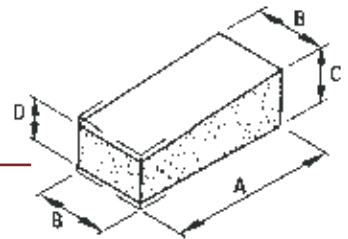

Radial Header

RD1

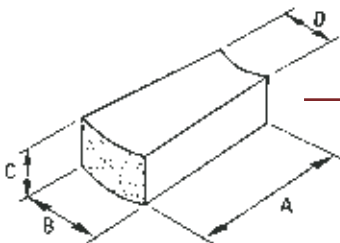

Radial Stretcher

RD2

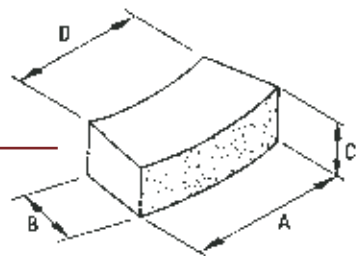

Brick Face Slip

SL1

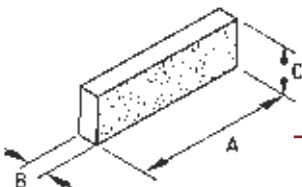

2001

A photograph of a brick fireplace with a wooden mantel. The mantel is decorated with a wooden sculpture on the left, a diamond-shaped tile in the center, and another wooden sculpture on the right. A potted plant is on the left, and a wooden chair is on the right. A vase is on the floor in front of the fireplace. The fireplace has a small fire burning inside. The floor is made of large, square tiles.

Fireplaces & Other Products

YORK
Handmade

Fireplaces



Fireplaces

S710

Fireplaces constructed in York Handmade bricks, typically in 50mm format, bring warmth and character to any home. This example shows an Inglenook detail incorporating our 50mm Old Clamp Blend.

Other Products



Pillar Capping

A traditional finish for a gatepost or wall end.

YHMB15



Dateblock

A perfect way to record the date on which your property was built.

YHMB8



Winestackers

Made from the local lacustrine clay found in the Vale of York each stacker ensures that wine is stored at a cool even temperature and keeps damaging ultraviolet rays away from the wine. The bottles are stored horizontally to help prevent the cork drying out.

YHMB16

Flat Arch

This keystone, from which the arch bricks are offset, provides an attractive but simple to build feature on the house. The arch is designed to course with 65mm bricks.

YHMB17

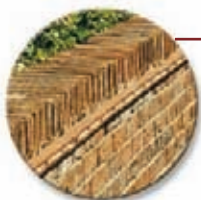

Crease Tiles

Crease tiles are used in free standing walls. Whilst aesthetically pleasing they are also the best method of construction to avoid staining and to aid durability. See YHM technical note on crease tiles in conjunction with wall coping/capping.

YHMB18

New Products - Byland



Rose Brick

215 x 110 x 65 YHMB20



Cloister Garden Edging

250 x 260 x 20 YHMB21



Diamond Paver

215 x 110 x 65 YHMB22

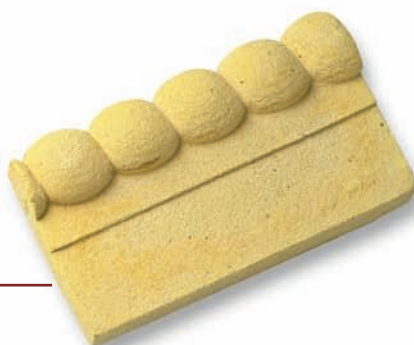

Rope Garden Edging

260 x 150 x 30 YHMB23

Upright Garden Edging

250 x 100 x 50 YHMB25



Oak Leaf Paver

215 x 102 x 65 YHMB24



Samples

Samples can be despatched to any part of the country within 48 hours.

Bricks can also be supplied for sample panels on site on request.

Literature

Please contact this office if you require any further info on YHM Landscape Products, Specials or Restoration.

Showroom

There is a showroom and display area at the factory nine miles north of York (just off A19).

The showroom is open in normal office hours and on Saturday mornings up to 12 noon, although please check opening times with the office if you are travelling a distance to get to us.

Garden edgings are the ideal complement to handmade pavers or can be used with other landscape materials.





Forest Lane, Alne, York YO61 1TU

Tel: 01347 838881 Fax: 01347 838885

www.yorkhandmade.co.uk

email: sales@yorkhandmade.co.uk